



Metalico Plus

TEHNOPANELI-DIZAJN d.o.o.

Izložbeno-prodajni salon
Obrtnička 3, 10000 Zagreb
(Savica-Šanci)

Skladište
Majstorska 11

T: 01 6040 105, 6040 106,
6040 108 i 618 4037
F: 01 618 4337
E: prodaja@tehnopaneli.hr
www.tehnopaneli.hr

Metalico Plus

Program Metalico Plus predstavlja novi korak u dizajniranju funkcionalnih i estetski kvalitetnih rješenja za vaš ured. Radne ploče u modernim svijetlim bojama, nježnom javoru i toplom bijeljenom hrastu, ili pak elegantnoj zlatnoj trešnji, omogućit će i najprobirljivijem kupcu da pronađe svoj izbor. Dinamičnost programu daje kontrast koji nastaje između radnih ploča u drvenim dekorima i metalne potkonstrukcije u boji aluminija. Dinamične forme radnih ploča i dekorativni elementi koji ih nadopunjuju čine modularni sistem programa Metalico Plus koji daje životnost konceptu timskog rada. Istovremeno, pregrade u toplim živim bojama kao što su crvena i žuta omogućavaju individualnost u radu i vizualnu odvojenost. Radni prostor opremljen programom Metalico Plus, te pratećim programom ormara Novus Plus, osim svoje funkcionalnosti, pružit će dojam transparentnosti, lakoće, modernog dizajna... operativnog prostora po mjeri čovjeka. Modularno rješenje "repcije" iz programa Metalico Plus pružit će istovremeno operativnu racionalnost za zaposlenike i estetsku udobnost dobrodošlice za posjetitelje.

Metalico Plus programme represents a new step in the design of the functional and esthetic quality solutions for your office.

Working surfaces are executed in modern light colours, of the gentle maple, whitened oak or the elegant golden cherry that will enable even the most choosy customer to find his own choice.

The dynamic programme contrasts the working surface in wooden decorations and metal aluminium coloured construction.

The working surface dynamic forms and the decorative elements represent the modular programme system Metalico Plus giving life to the team concept of work.

The partiitions in warm lively cloours such as red and yellow enable, at the same time, individuality at work and a visual separation.

The working space equipped with the Metalico Plus programme as well as the wardrobe from the Novus Plus programme following it give, next to the functionality, an impression of transparency in a light modern design – working space designed for people.



1



2



3



4



5



6

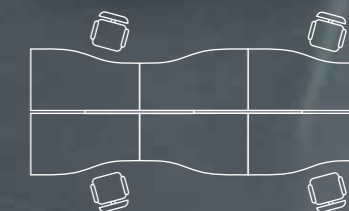

Metalico Plus

1

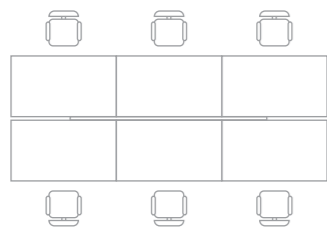

Radni stolovi se mogu međusobno pregraditi pregradama u više dezena koje se pričvršćuju nosačima u boji aluminija.

The desks may be mutually separated by partitions in several designs fastened with the carriers in the aluminum colour.



Intimna zona radnog mjesta zaštićena je metalnom perforiranom maskom u boji aluminija.
An intimate working zone protected with a metal perforated mask in the aluminum colour.

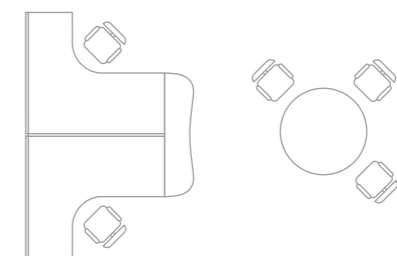





Metalna potkonstrukcija radnih i konferencijskih stolova lakirana je u boju aluminija u satiniranoj izvedbi.
Metal desk and conference table sub-structure varnished in the aluminium colour and satin execution.

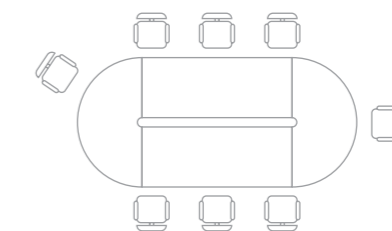

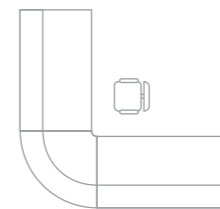

Metalico Plus
6

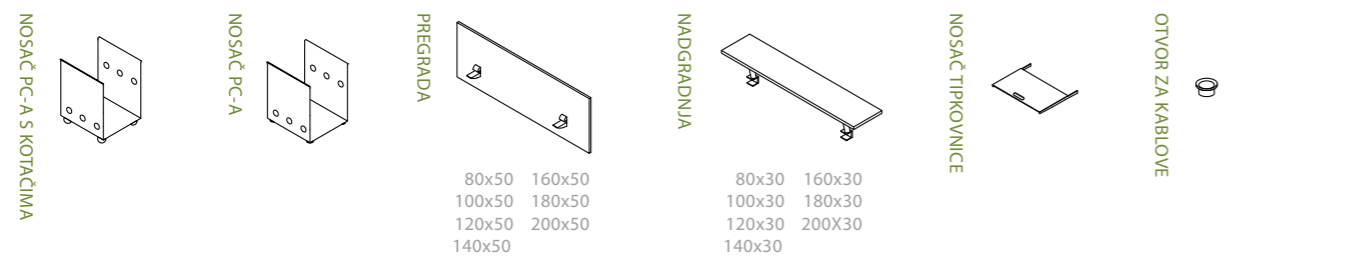
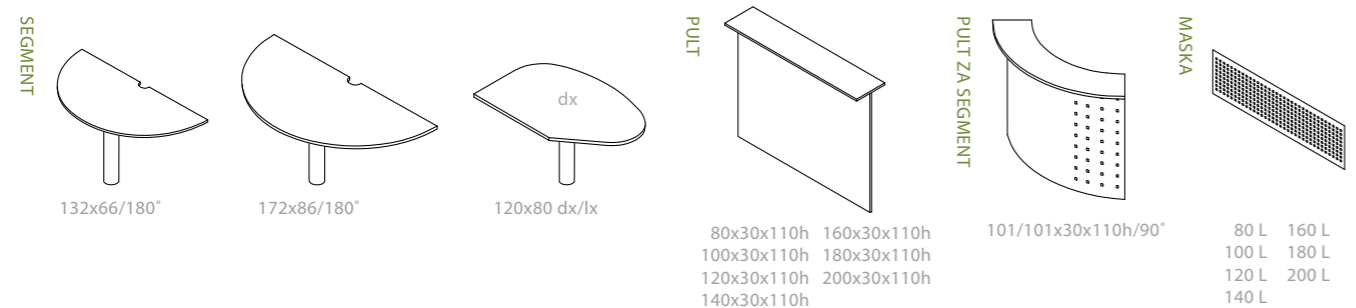
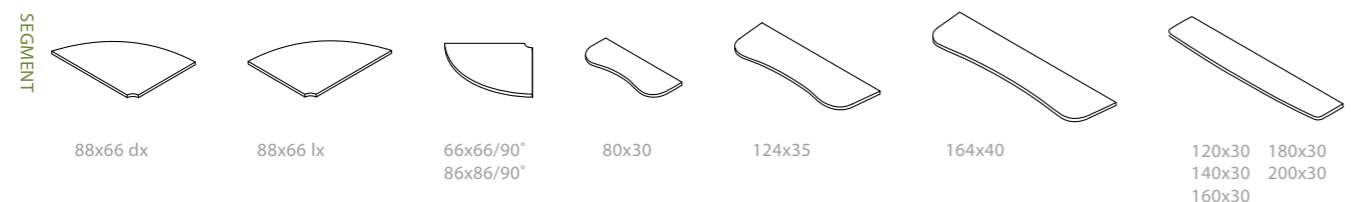
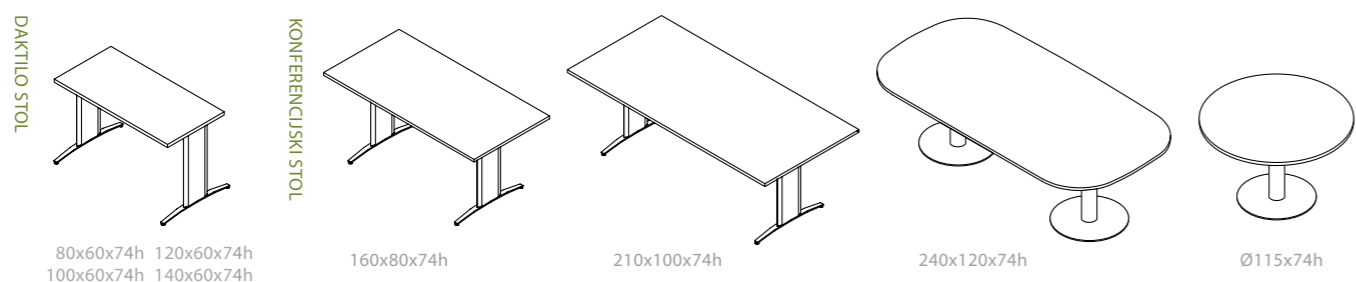
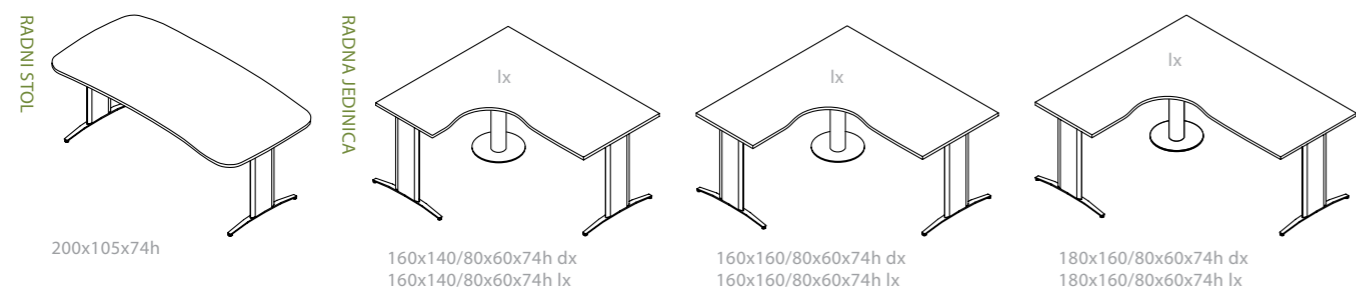
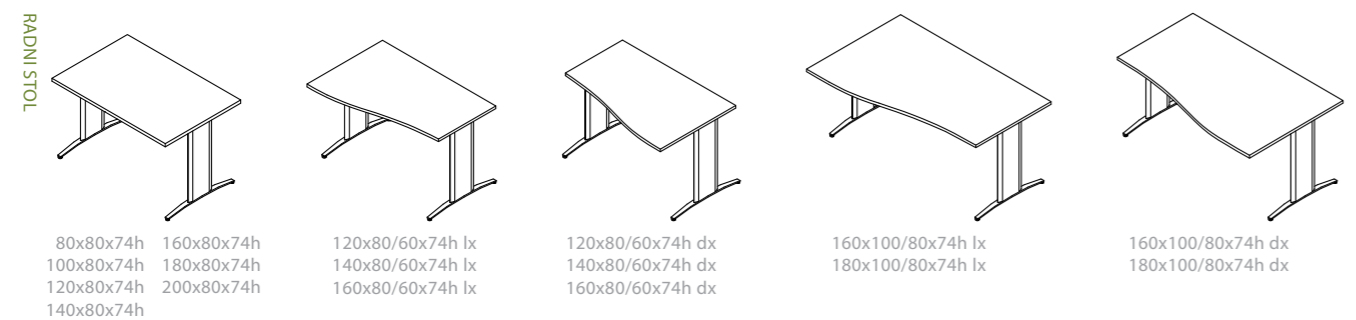

Metalico Plus

Novus Plus

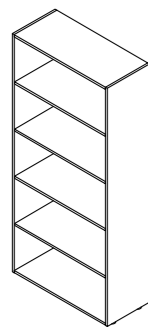

ART.100
90x40x198h

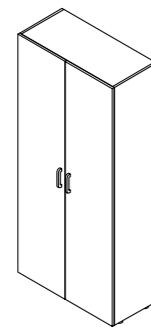

ART.101
90x42x198h

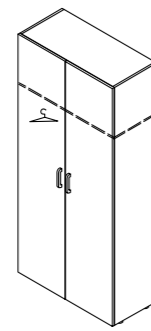

ART.101G
90x42x198h

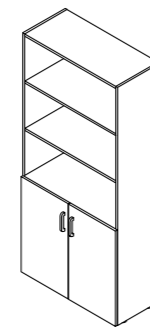

ART.103
90x42x198h

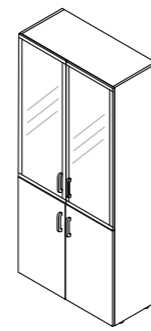

ART.104
90x42x198h

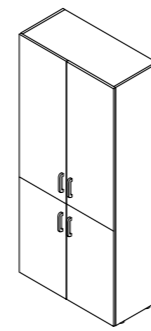

ART.105
90x42x198h

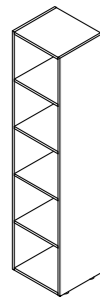

ART.106
45x40x198h

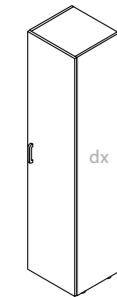

ART.107
45x42x198h dx/lx

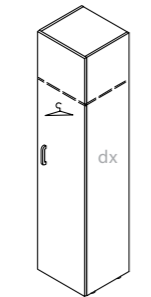

ART.107G
45x42x198h dx/lx

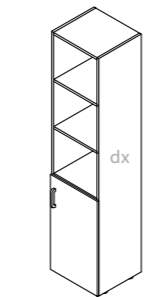

ART.109
45x42x198h dx/lx



ART.110
45x42x198h dx/lx

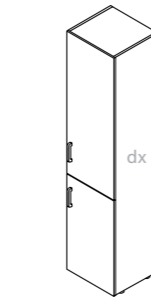

ART.111
45x42x198h dx/lx

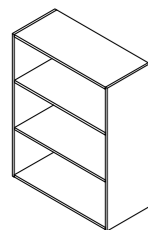

ART.200
90x40x119h

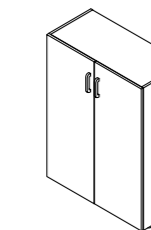

ART.201
90x42x119h



ART.202
90x42x119h

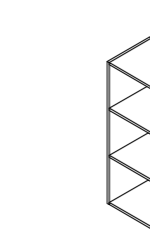

ART.203
45x40x119h

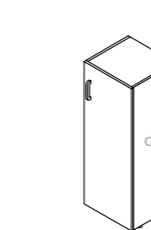

ART.204
45x42x119h dx/lx

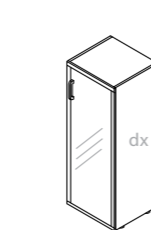

ART.205
45x42x119h dx/lx

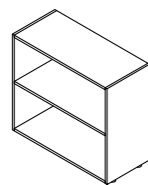

ART.300
90x40x80h

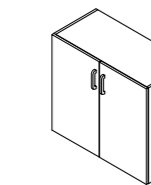

ART.301
90x42x80h

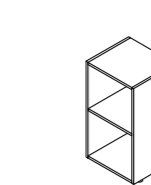

ART.302
45x42x80h

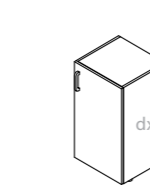

ART.303
45x40x80h dx/lx

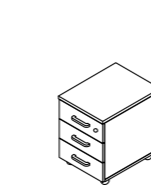

ART.500
42x54x58h 1/3

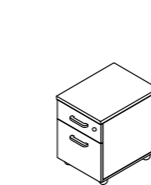

ART.501
42x54x58h 1/2



BRAVICA ZA DRVO

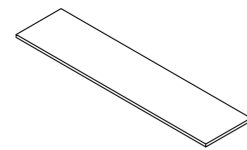

ART.400 45x43x2,8 ART.403 180x43x2,8
ART.401 90x43x2,8 ART.404 225x43x2,8
ART.402 135x43x2,8

TEHNO PANELI
uredski namještaj

Izložbeno-prodajni salon
Obrtnička 3, 10000 Zagreb
(Savica-Šanci)

Skladište
Majstorska 11

Tel: 01 6040 105
01 6040 106
01 6040 108
01 618 4037

Faks: 01 618 4337

E-pošta: prodaja@tehnopaneli.hr